

Scarlett 8i6

User Guide

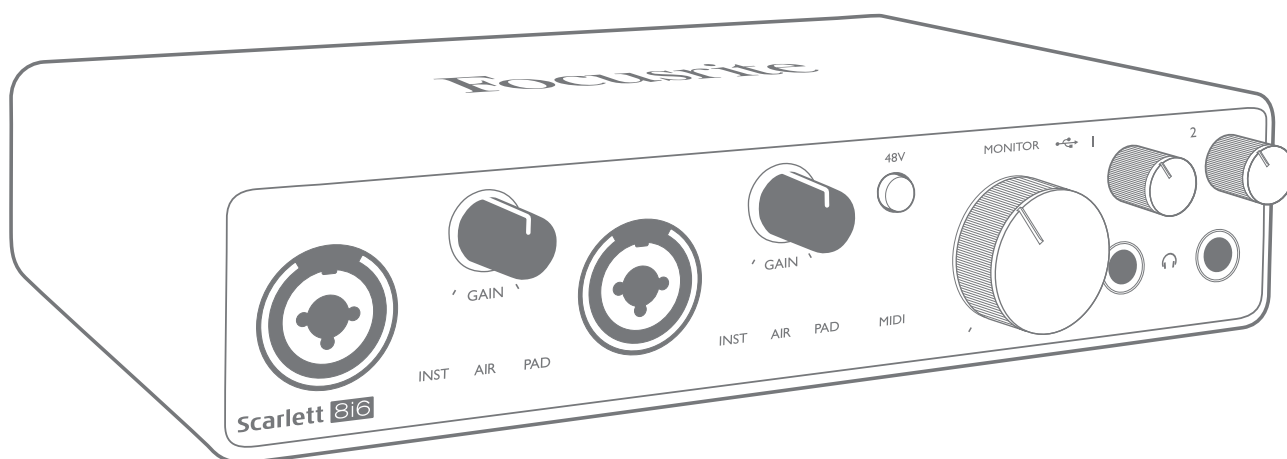

TABLE OF CONTENTS

OVERVIEW	3
Introduction	3
Features	3
Box Contents	4
System requirements	4
GETTING STARTED	5
Quick Start Tool	5
Mac users only	5
Windows only	7
All users	9
Manual Registration	9
HARDWARE FEATURES	10
Front Panel	10
Rear Panel	12
Connecting your Scarlett 8i6	13
Power	13
USB	13
Audio Setup in your DAW	14
Loopback Inputs	15
Examples of Usage	16
Connecting microphones and instruments	16
Low Latency Monitoring	17
Creating an effects loop	18
Using the Scarlett 8i6 as a stand-alone mixer	19
FOCUSRITE CONTROL	20
SPECIFICATIONS	22
Performance Specifications	22
Physical and Electrical Characteristics	24
TROUBLESHOOTING	26
COPYRIGHT AND LEGAL NOTICES	26

OVERVIEW

Introduction

Thank you for purchasing this Third Generation Scarlett 8i6, one of the family of Focusrite professional audio interfaces incorporating high quality Focusrite analogue pre-amplifiers. In conjunction with the unit's accompanying software application, Focusrite Control, you now have a compact yet highly versatile solution for routing high quality audio to and from your computer. You can also use the Scarlett 8i6 as a "stand-alone" interface to any other type of recording device, once you have configured it using Focusrite Control.

In developing the Third Generation series of Scarlett interfaces, we have made further improvements to both performance and features. Audio specifications have been upgraded throughout the unit to give you greater dynamic range and even lower noise and distortion; additionally, the mic preamp now accepts higher input levels. An important enhancement is the inclusion of Focusrite's AIR function. Individually selectable on Inputs 1 and 2, AIR subtly modifies the preamp's frequency response to model the sonic characteristics of our classic transformer-based ISA microphone preamps. When recording with good quality microphones, you will notice an enhanced clarity and definition in the important mid to high frequency range, just where it is most needed for vocals and many acoustic instruments. Third Generation Scarlett interfaces are class compliant on macOS: this means they are plug-and-play, so no need to install a driver if you are a Mac user.

Your Third Generation Scarlett interface is compatible with our Focusrite Control software application: this lets you control various hardware features, set up monitor mixes and configure routings. There is a Focusrite Control installer for both Mac and Windows platforms. The Windows version of the installer contains the driver, so in either case, you only need to install Focusrite Control to get up and running.

This User Guide provides a detailed explanation of the hardware to help you achieve a thorough understanding of the product's operational features. We recommend that you take the time to read through the User Guide, whether you're new to computer recording or a more experienced user, so that you are fully aware of all the possibilities that the Scarlett 8i6 and accompanying software have to offer. If the main User Guide sections do not provide the information you need, be sure to consult <https://support.focusrite.com/>, which contains a comprehensive collection of answers to common technical support queries.

Features

The Scarlett 8i6 audio interface provides the means for connecting microphones, musical instruments, line level audio signals and S/PDIF digital audio signals to a computer running compatible versions of macOS or Windows. The signals at the physical inputs can be routed to your audio recording software / digital audio workstation (referred to throughout this user guide as the "DAW") at up to 24-bit, 192 kHz resolution; similarly, the DAW's monitor or recorded output signals can be configured to appear at the unit's physical outputs.

The outputs can be connected to amplifiers and speakers, powered monitors, headphones, an audio mixer or any other analogue or digital audio equipment that you wish to use. Although all inputs and outputs on the Scarlett 8i6 are routed directly to and from your DAW for recording and playback, you can configure the routing within your DAW in order to meet your precise needs.

The accompanying software application, Focusrite Control, provides further routing and monitoring options, as well as the ability to control global hardware settings such as sample rate and synchronisation.

All inputs on the Scarlett 8i6 are routed directly to your DAW software for recording, but Focusrite Control also allows you to route these signals internally within the device to the outputs so that you can monitor the audio signals with ultra-low latency - before they arrive at your DAW, should you need to do so.

The Scarlett 8i6 also has connectors for sending and receiving MIDI data; this lets you use it as a MIDI interface between your computer's USB port and other items of MIDI equipment in your system.

Box Contents

Along with your Scarlett 8i6 you should find:

- External 12 V DC mains Power Supply Unit (PSU)
- USB cable, Type 'A' to Type 'C'
- Getting Started Information (printed on inside of box lid)
- Important Safety Information

System requirements

The easiest way to check that your computer's operating system (OS) is compatible with the Scarlett 8i6 is to use our online OS Checker at <https://customer.focusrite.com/downloads/os>. As new OS versions become available over time, you can continue to check for further compatibility information by searching our Help Centre at <https://support.focusrite.com/hc/en-gb>.

GETTING STARTED

With the Third Generation, Scarlett interfaces introduce a new, faster way of getting up and running, using the Scarlett Quick Start tool. All you need to do is connect your Scarlett 8i6 to your computer. Once connected, you will see that the device is recognised by your PC or Mac and the Quick Start tool will guide you through the process from there.

IMPORTANT: The Scarlett 8i6 has a single USB 2.0 Type C port (on the rear panel): connect it to your computer using the USB cable provided. Note that Scarlett 8i6 is a USB 2.0 device, and thus the USB connection requires a USB 2.0+ compliant port on your computer.

Your computer will initially treat your Scarlett as a Mass Storage Device (MSD), and during its first connection, the Scarlett will be in “MSD Mode”

Quick Start Tool

We have tried to make registering your Scarlett 8i6 as simple as possible. The procedure will probably be self explanatory, but we have described each step below, so you can see how they should appear on either a PC or a Mac.

Mac users only:

On connecting your Scarlett 8i6 to your Mac, a Scarlett icon will appear on the desktop:



Double-click on the icon to open the Finder window shown below:

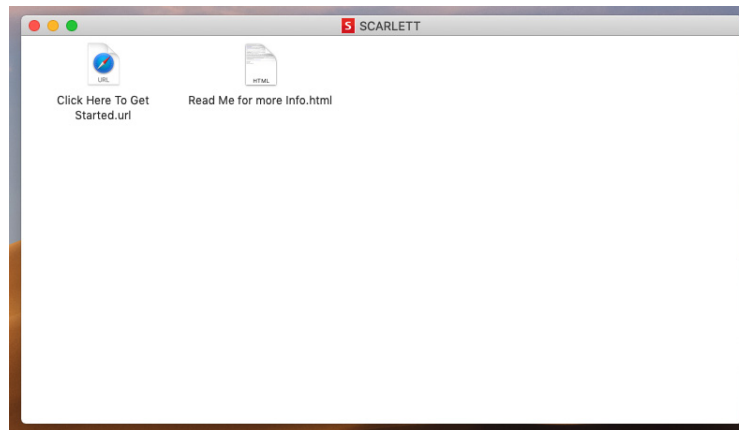

Double-click on the "Click Here to Get Started.url" icon. This will redirect you to the Focusrite website, where we recommend that you register your device:



Click on "Let's get you started", and you'll be presented with a form which will be partly prefilled for you automatically. On submitting the form, options will be presented to either go straight to the downloads area to get the software for your Scarlett, or to follow a step by step setup guide based on your choices. Once you have installed the Focusrite Control software to set up and configure your interface, the Scarlett will be switched out of MSD mode so that it no longer appears as a Mass Storage Device when connected to your computer.

Your OS should automatically switch the computer's default audio inputs and outputs to the Scarlett 8i6. To verify this, go to **System Preferences > Sound**, and ensure that the input and output are set to **Scarlett 8i6**. For more detailed setup options on a Mac, open: **Applications > Utilities > Audio MIDI Setup**.

Windows only:

On connecting your Scarlett 8i6 to your PC, a Scarlett icon will appear on the desktop:

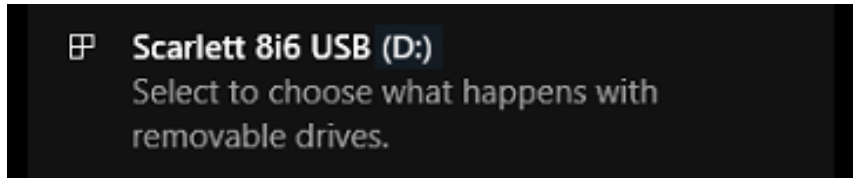

(Note that the drive letter may be something other than D:, depending on what other devices you have connected to your PC).

Double-click on the pop-up message to open the dialogue box shown below:

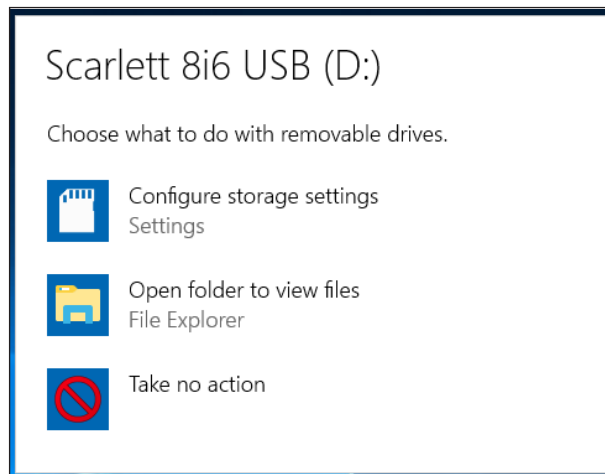

Double-click on “Open folder to view files”: this will open an Explorer window:

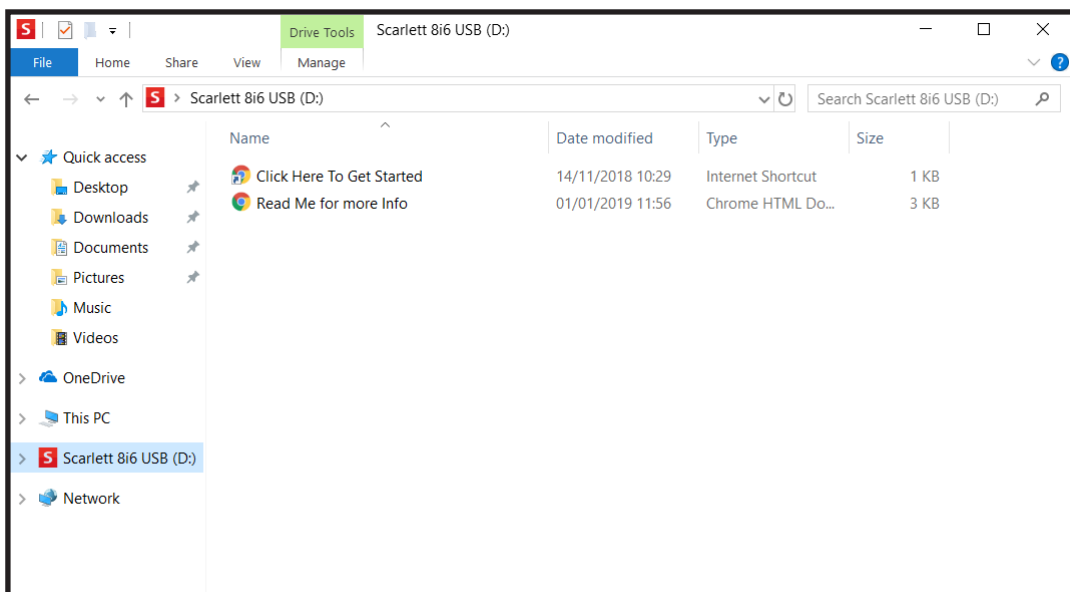

Double-click “Click Here to Get Started”.

This will redirect you to the Focusrite website, where we recommend that you register your device:



Click on “Let’s get you started”, and you’ll be presented with a form which will be partly prefilled for you automatically. On submitting the form, options will be presented to either go straight to the downloads to get the software for your Scarlett, or to follow a step-by-step setup guide based on your choices. Once you have installed the Focusrite Control software to set up and configure your interface, the Scarlett will be switched out of MSD mode so that it no longer appears as a Mass Storage Device when connected to your computer.

Your OS should automatically switch the computer’s default audio inputs and outputs to be the Scarlett 8i6. To verify this, right click on the Sound icon on the taskbar and select **Sound Settings**, and set the Scarlett as the Input and Output Device.

All users:

Note that a second file - "More Info & FAQs" - is also available during the initial set-up process. This file contains some additional information about the Focusrite Quick Start tool which you may find helpful if you have any issues with the procedure.

Once registered, you will have immediate access to the following resources:

- Focusrite Control (Mac and Windows versions available) - see NOTE below
- Multi-language User Guides

Licence codes and links will be provided for the following bundled software within your account page.

- Pro Tools | First
- Ableton Live Lite
- Focusrite Red 2 & 3 Plug-in Suite
- Softube Time and Tone bundle
- XLN Audio Addictive Keys
- Plug-in Collective Offers

NOTE: Installing Focusrite Control will also automatically install the correct driver for your device. Focusrite Control is available to download at any time, even without registering: see "Manual Registration" below.

Manual Registration

If you decide to register your Scarlett 8i6 at a later date you can do so at <https://customer.focusrite.com/user/register>. You will need to enter the Serial Number manually: this number can be found on the base of the interface itself, and can also on the barcode label on the side of the box.

We recommend that you download and install our Focusrite Control application, as this will disable MSD mode and unlock the full potential of the interface. Initially, when in MSD mode, the interface will function at sample rates up to 48 kHz. Once Focusrite Control is installed on your computer, you can work at sample rates up to 192 kHz. If you decide not to download and install Focusrite Control immediately, it can be downloaded at any time from: <https://customer.focusrite.com/support/downloads>.

In order to force your Scarlett 8i6 out of MSD mode without first registering it, hold down the **48V** button while disconnecting and reconnecting the USB cable, and then continue to hold the **48V** button for a further five seconds. This will ensure that your Scarlett 8i6 has full functionality. Please bear in mind that should you wish to register your Scarlett 8i6 after taking this action, you will need to do so manually, as explained above.

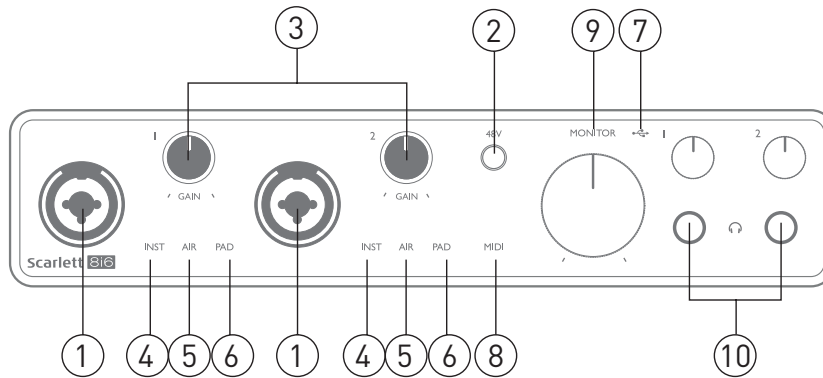

HARDWARE FEATURES

Front Panel





The front panel includes input connectors for Mic, Line and Instrument signals, the input gain and monitoring controls, and headphones sockets.

1. Inputs 1 & 2 – “Combo” type input sockets - connect microphones, instruments (e.g., guitar), or line level signals here. Combo sockets accept both XLR and ¼” (6.35 mm) jacks. Microphones will normally be connected using XLR plugs: instruments and line level signals should be connected via ¼” (6.35 mm) jack plugs of either TR or TRS type. The preamp gain is appropriate for microphones when an XLR plug is inserted, and for higher level signals when a jack plug is inserted. Do not connect anything other than a microphone - e.g., the output of a sound module or FX unit - via an XLR plug, as the signal level will overload the preamp, resulting in distortion; also, if phantom power is enabled, the equipment may be damaged.
2. **48V** – press to enable 48 V phantom power at the XLR contacts (mic inputs) of the Combo connectors. The **48V** indicator illuminates red when phantom power is selected.
3. **GAIN 1** and **GAIN 2** - adjust the input gain for the signals at Inputs 1 and 2 respectively. The gain controls have concentric tri-colour LED ‘rings’ to confirm signal level: green indicates an input level of at least -24 dBFS (i.e., ‘signal present’), the ring then turns amber at -6 dBFS to indicate that the signal is close to clipping, and finally to red at 0 dBFS (digital clipping).
4. **INST** – the input configuration for the jack contacts at Inputs 1 and 2 can be selected in software from Focusrite Control. The red LEDs illuminate when INST is selected. With INST selected, the gain range and input impedance are altered (relative to LINE), and the input is made unbalanced. This optimises it for the direct connection of instruments (usually via a 2-pole (TS) jack plug). When INST is off, the inputs are suitable for the connection of line level signals. Line level signals may be connected either in balanced form via a 3-pole (TRS) jack or unbalanced, via a 2-pole (TS) jack.
5. **AIR** – two yellow LEDs indicating selection of AIR mode for Inputs 1 and 2. AIR mode, selected from Focusrite Control, modifies the frequency response of the input stage to model the classic, transformer-based Focusrite ISA microphone preamps.
6. **PAD** – two green LEDs; illuminate when PAD is selected from Focusrite Control for Inputs 1 and 2. PAD decreases the signal level going to your DAW by 10 dB; use when the input source has a particularly high level.

7.  USB LED - a green LED which illuminates when the unit is recognised by the computer to which it is connected.
8. **MIDI** LED – green LED, illuminates when MIDI data is received at the **MIDI IN** port.
9. **MONITOR** – main monitor output level control – this is an analogue control and adjusts the level at Outputs 1 and 2 on the rear panel.
10.  - connect one or two pairs of stereo headphones at the two ¼" (6.25 mm) TRS jack sockets below the headphone volume controls. The headphone outputs always carry the signals that are currently routed to analogue outputs 1 & 2 and 3 & 4 respectively (as stereo pairs) in Focusrite Control.

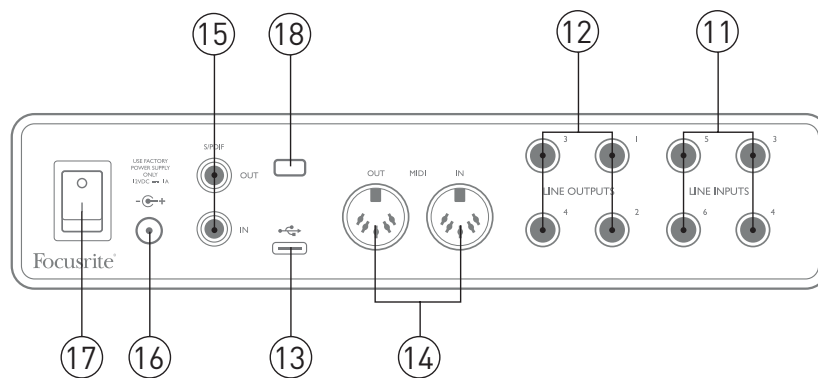
Rear Panel



11. **LINE INPUTS 3 to 6** – four balanced analogue line inputs on ¼" (6.35 mm) jack sockets. Connect further line level sources here, using either ¼" TRS (balanced) or TS (unbalanced) jack plugs.
12. **LINE OUTPUTS 1 to 4** – four balanced analogue line outputs on ¼" (6.35 mm) jack sockets; use TRS jacks for a balanced connection or TS jacks for unbalanced. Outputs 1 and 2 will normally be used to drive the primary monitoring system, though the signals available at any of these outputs may be defined in Focusrite Control. Outputs 3 and 4 can typically be used for driving alternative speakers (i.e., midfield, nearfield, etc.), or to drive outboard FX processors.
13.  USB 2.0 port – Type C connector; connect the Scarlett 8i6 to your computer with the cable supplied.
14. **MIDI IN** and **MIDI OUT** – standard 5-pin DIN sockets for connection of external MIDI equipment. The Scarlett 8i6 acts as a MIDI interface, allowing MIDI data to/from your computer to be distributed to additional MIDI devices.
15. **SPDIF IN** and **OUT** – two phono (RCA) sockets carrying two-channel digital audio signals in or out of the Scarlett 8i6 in S/PDIF format. These are essentially Inputs 7 and 8 and Outputs 5 and 6 to/from the unit. Like all the other inputs and outputs, signals at these connectors may be routed in Focusrite Control.
16. External DC power input – the Scarlett 8i6 is powered from the supplied AC adaptor (PSU), rated at 12 V DC and 1 A; the polarity of the coaxial connector is with positive (+12 V) on the centre pin. Note that the Scarlett 8i6 cannot be powered via its USB port from the host computer.
17. Power On/Off switch.
18. **K** (Kensington security lock)– secure your Scarlett 8i6 to a suitable structure if desired.

Connecting your Scarlett 8i6

Power

Your Scarlett 8i6 should be powered from an external 12 V DC, 1 A mains adaptor. A suitable adaptor is supplied with the unit.

IMPORTANT: We very strongly recommend that you only use the supplied mains adaptor. Failure to use this adaptor is likely to permanently damage the unit and will also invalidate your warranty.

USB

USB Port Types: The Scarlett 8i6 has a single Type C USB 2.0 port (on the rear panel). Once the software installation is complete, simply connect the Scarlett 8i6 to your computer; if your computer has a Type A USB port we recommend you use the Type A-to-Type C USB cable provided with the unit. If your computer has a Type C USB port, please obtain a Type C-to-Type C cable from a computer supplier.

USB Standards: Note that because the Scarlett 8i6 is a USB 2.0 device, the USB connection requires a USB 2.0-compliant port on your computer. It will not operate correctly with USB 1.0/1.1 ports: however, typically a USB 3.0 port will support a USB 2.0 device.

When the USB cable has been connected, turn the Scarlett 8i6 on with the rear panel power switch.

Audio Setup in your DAW

The Scarlett 8i6 is compatible with any Windows-based DAW that supports ASIO or WDM or any Mac-based DAW that uses Core Audio. After following the Getting Started procedure described on page 5, you can start using your Scarlett 8i6 with the DAW of your choice. To allow you to get started if you do not already have a DAW application installed on your computer, both ProTools | First and Ableton Live Lite are included; these will be available to you once you've registered your Scarlett 8i6. If you need help installing either DAW, please visit our Getting Started pages at <http://focusrite.com/get-started>, where Getting Started videos are available.

Operating instructions for Pro Tools | First and Ableton Live Lite are beyond the scope of this User Guide, but both applications include a full set of Help files. Instructions are also available at www.avid.com and www.ableton.com respectively.

Please note - your DAW may not automatically select the Scarlett 8i6 as its default I/O device. In this case, you must manually select **Focusrite USB ASIO** as the driver on your DAW's **Audio Setup*** page. Please refer to your DAW's documentation (or Help files) if you are unsure where to select the ASIO/ Core Audio driver. The example below shows the correct configuration in the Ableton Live Lite **Preferences** panel (Windows version shown).

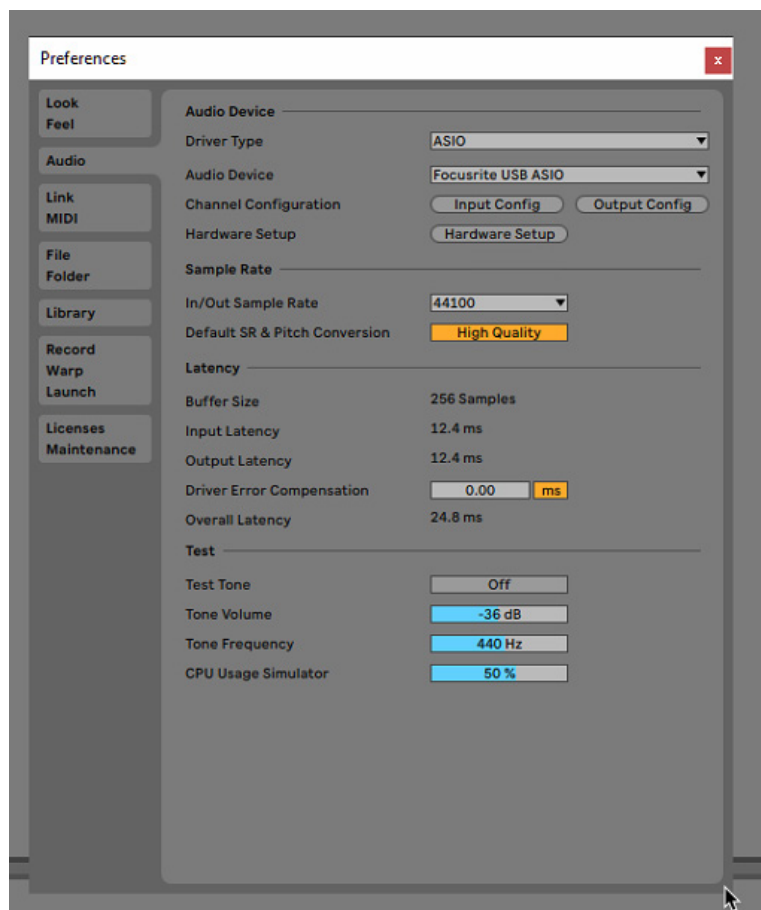

* Typical name. Terminology may differ slightly between DAWs.

Once the Scarlett 8i6 is set as the preferred Audio Device* in your DAW, all eight inputs and six outputs will appear in your DAW's Audio I/O preferences (note however that Ableton Live Lite is limited to a maximum of four simultaneous mono input channels and four simultaneous mono output channels). Depending on your DAW, you may need to enable certain inputs or outputs before use. The two examples below show two inputs and two outputs enabled in Ableton Live Lite's **Input Config** and **Output Config** pages.

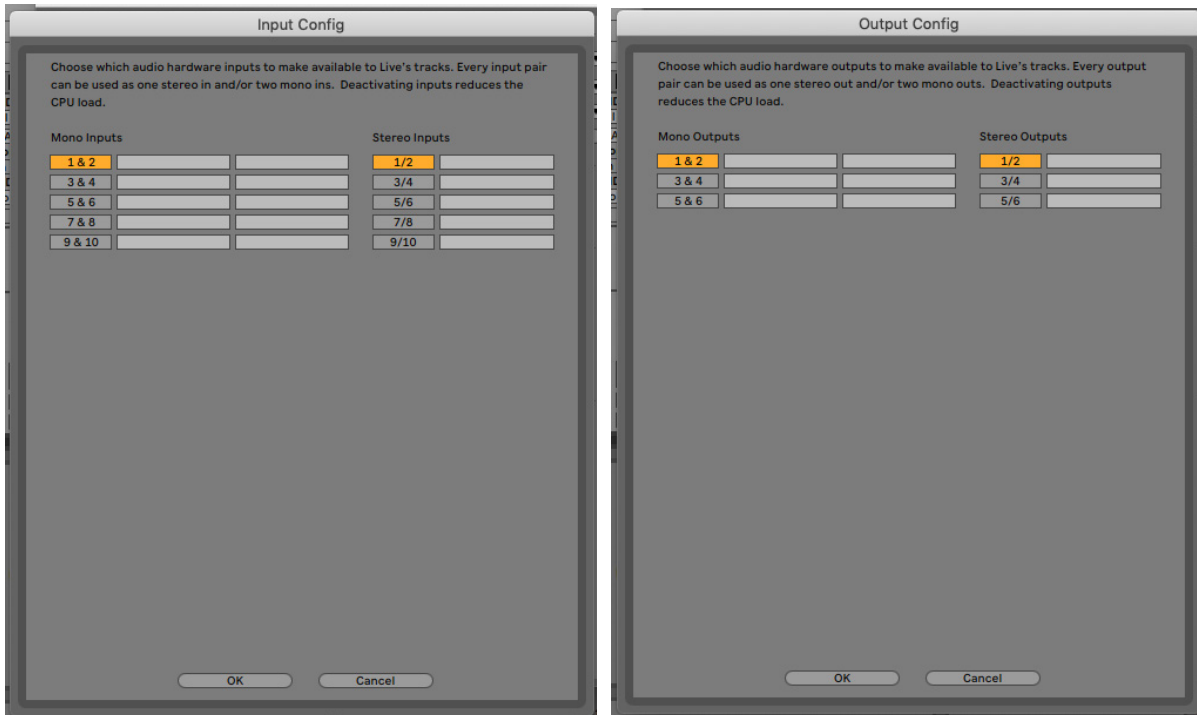

* Typical name. Terminology may differ slightly between DAWs.

Loopback Inputs

You will notice that two additional inputs - "Inputs 9 & 10" - will be listed on the Input Config page of your DAW's I/O Preferences. These are virtual "loopback" inputs within software, not additional physical inputs. They can be used to record DAW tracks from sources within your computer, e.g., from a web browser. Focusrite Control includes a Loopback 1-2 mix tab, where you can choose which inputs to record.

Full details of how to use the loopback inputs can be found in the Focusrite Control User Guide.

Examples of Usage

The Scarlett 8i6 is an excellent choice for several different recording and monitoring applications. Some typical configurations are shown below.

Connecting microphones and instruments

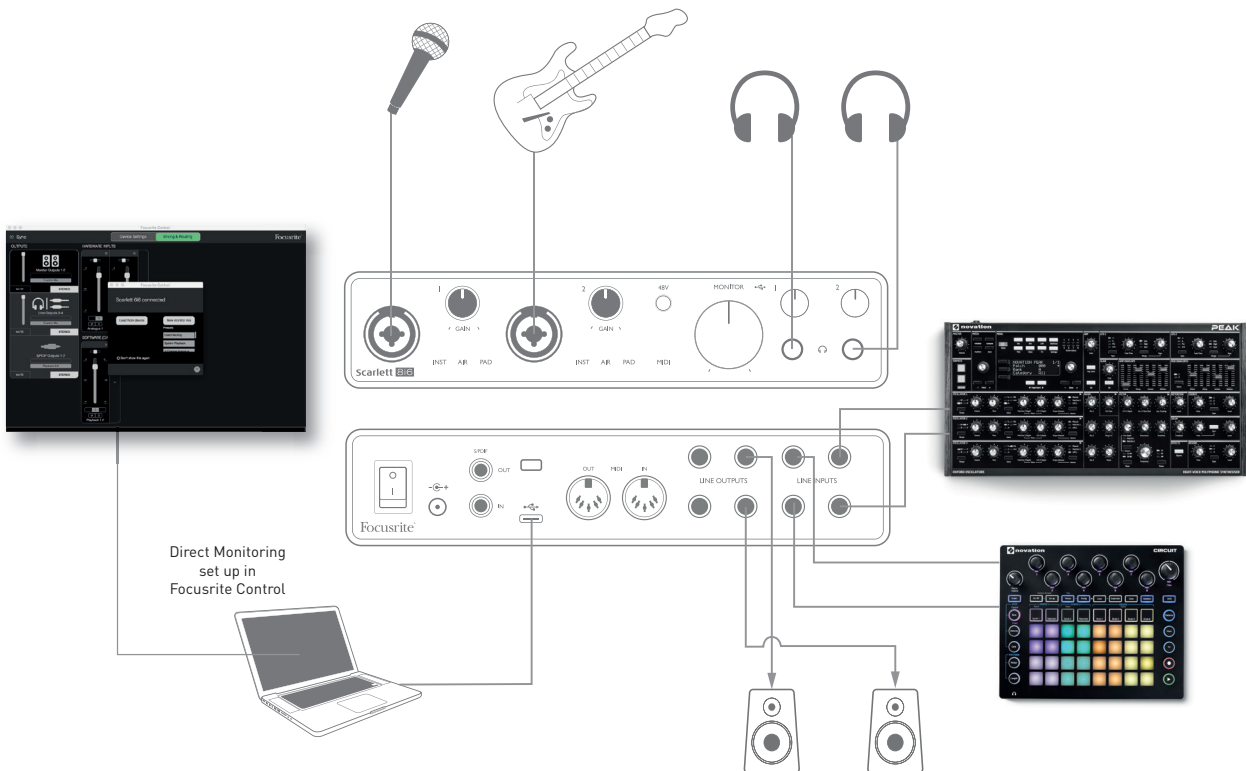

This setup illustrates a configuration for recording a vocalist and a guitarist together with a keyboard and a drum machine using DAW software on Mac or PC. In this case, Inputs 1 and 2 are used for vocals and guitar respectively, Inputs 3 and 4 receive the stereo output of the keyboard and Inputs 5 and 6 are used for the drum machine. Each source will be recorded on a separate track (or stereo pair of tracks) of the DAW. During recording, a mix of the instruments and the vocalist, plus the playback of any tracks already recorded in the DAW, can be monitored on headphones. Alternatively, loudspeakers can be used if the vocal mic is in a separate room. The mix itself is set up in Focusrite Control.

The front panel input sockets are XLR Combo type, which accept either an XLR male connector (you will probably have one on the end of your microphone cable) or a 1/4" (6.35 mm) jack plug. Note the Scarlett 8i6 has no "Mic/line" switch – the Focusrite preamplifier stage is automatically configured for a microphone when you plug an XLR into the input, and for a line or instrument when you connect a jack plug. Select **INST** in Focusrite Control (on the **Input Settings** page) if you are connecting a musical instrument such as a guitar with an ordinary 2-pole guitar jack. **INST** should be off if you are connecting a line level source such as the balanced output of an external audio mixer via a 3-pole (TRS) jack. Note the Combo connector accepts both types of jack plug.

If you are using a capacitor (condenser) microphone, press the **48V** button to supply phantom power to the mic. Most modern microphones of other types, e.g., dynamic or ribbon, will not be damaged by the inadvertent application of phantom power, but note that some older mics may be; if you have any doubt, please check the specification of your mic to ensure that it is safe to use.

Input channels 1 and 2 of the Scarlett 8i6 each have a PAD function: when selected from Focusrite Control (**PAD** illuminates green when active), the signal level fed to your DAW is reduced by 10 dB. You will find this useful if the output level of your source is particularly “hot”, when you might notice clipping or the gain halo turning red, even at minimum gain.

Low Latency Monitoring

You will frequently hear the term “latency” used in connection with digital audio systems. In the case of the simple DAW recording application described above, latency will be the time it takes for your input signals to pass through your computer and audio software, and back out again via your audio interface. While not an issue for most simple recording situations, under some circumstances, latency can be a problem for a performer who wishes to record while monitoring their input signals. This might be the case if you need to increase the size of your DAW’s recording buffer, which could be necessary when you record overdubs on a particularly large project using many DAW tracks, software instruments and FX plug-ins. Common symptoms of a buffer setting that is too low could be glitching audio (clicks and pops), or a particularly high CPU load within your DAW (most DAWs have a CPU load monitoring feature). Most DAWs will allow you to adjust buffer size from their Audio Preferences* control page.

The Scarlett 8i6, in conjunction with Focusrite Control, allows zero latency monitoring, which overcomes this problem. You can route your input signals directly to the Scarlett 8i6’s headphone and line outputs. This enables the musicians to hear themselves with ultra-low latency – i.e., effectively in “real time” – along with the computer playback. The input signals to the computer are not affected in any way by this setting. However, note that any effects being added to the live instruments by software plug-ins will not be heard in the headphones in this case, although the FX will still be present on the recording.

When monitoring your inputs through Focusrite Control, ensure that your DAW software is not set to route any inputs (what you are currently recording) to any outputs. If it is, the musicians will hear themselves “twice”, with one signal audibly delayed as an echo.

* Typical name. Terminology may differ slightly between DAWs

Creating an effects loop

The Scarlett 8i6 allows the easy integration of external outboard processors or effects. A good example is the inclusion of an outboard stereo compressor to a recording setup similar to that outlined above.

Connect Line Outputs 3 and 4 to the compressor's inputs, and the compressor's outputs to Line Inputs 3 and 4, as shown below. We have omitted the front panel connections in this example for clarity.

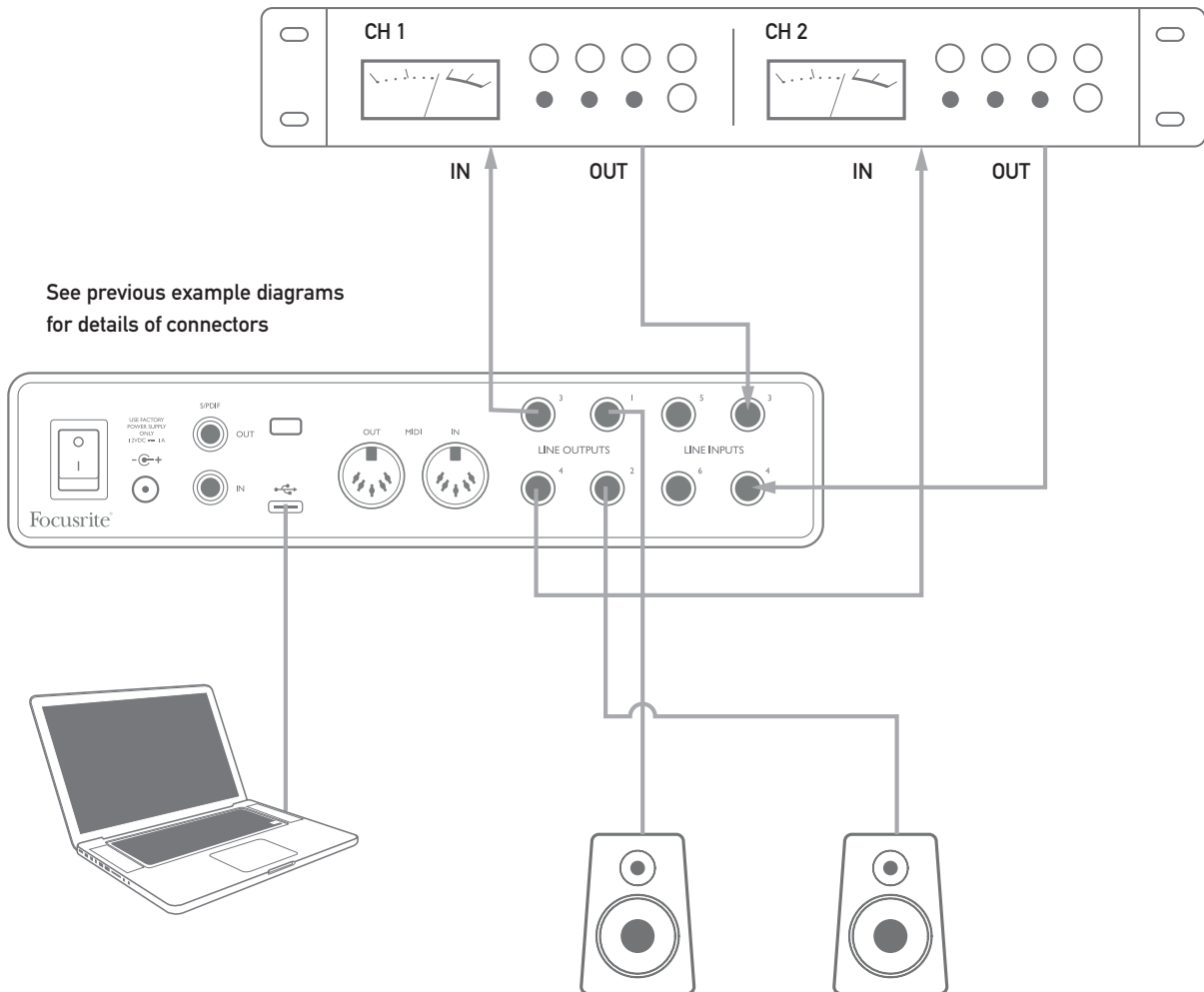

You can adjust the levels to and from the external processor from Focusrite Control, if necessary.

Using the Scarlett 8i6 as a stand-alone mixer

The Scarlett 8i6 has the ability to store a mix configuration defined in Focusrite Control within the hardware. This feature lets you configure it – for example, as an on-stage sub-mixer – using your computer, and then upload the configuration to the device itself. Then you can use the Scarlett 8i6 as a simple local mixer as part of your equipment rig to control the overall mix of multiple instruments.

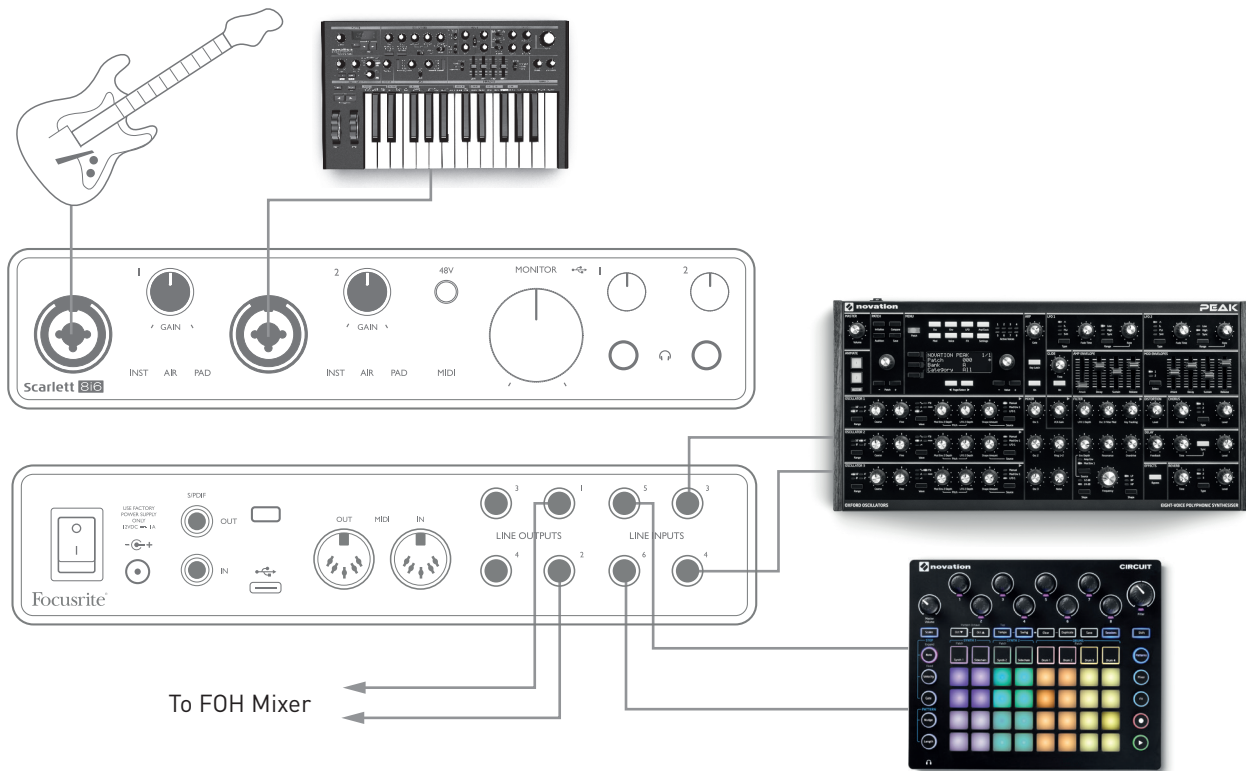

In the example illustrated, a guitar, stereo and mono synths and a electronic groovebox instrument are connected to the six analogue inputs of the Scarlett 8i6; Outputs 1 and 2 go to the main PA system. The player can set up a rough mix in Focusrite Control and then adjust the levels of the two mono sources against the stereo ones from the front panel.

FOCUSRITE CONTROL

Focusrite Control software allows flexible mixing and routing of all audio signals to the physical audio outputs, as well as control of output monitor levels. Sample rate selection and digital sync options are also available from Focusrite Control.

NOTE: Focusrite Control is a generic product, and may be used with other Focusrite hardware interfaces. When you connect an interface to your computer and launch Focusrite Control, the model of interface is automatically detected, and the software configured to suit the number of inputs and outputs, and other facilities, available on the hardware.

IMPORTANT: A separate Focusrite Control User Guide can be downloaded once you have completed the on-line registration process. This describes the use of Focusrite Control in full detail, together with examples of application.

To open Focusrite Control:



Installing Focusrite Control on your computer will place an FC icon on the dock or desktop. Click the icon to launch Focusrite Control.

Assuming that your Scarlett interface is connected to your computer with the USB cable, the Focusrite Control GUI (Graphical User Interface) will appear as shown below (Mac version illustrated).



Please refer to the Focusrite Control User Guide for further details.

The following table provides the channel routings when preset option “Direct Routing” is selected in Focusrite Control; see the screen image on page 20.

CH NO.	INPUTS	OUTPUTS
1	Input 1	Output 1 (Headphones 1L)
2	Input 2	Output 2 (Headphones 1R)
3	Input 3	Output 3 (Headphones 2L)
4	Input 4	Output 4 (Headphones 2R)
5	Input 5	S/PDIF 1
6	Input 6	S/PDIF 2
7	S/PDIF 1	
8	S/PDIF 2	
9	Loopback 1	
10	Loopback 2	

Please refer to the Focusrite Control User Guide for further details.

SPECIFICATIONS

Performance Specifications

NOTE: All performance figures measured in accordance with the provisions of AES17, as applicable.

Configuration	
Inputs	8: analogue (6), S/PDIF (2)
Outputs	6: analogue (4), S/PDIF (2)
Mixer	Fully assignable 8-in/6-out software mixer (Focusrite Control)
Supported sample rates	44.1 kHz, 48 kHz, 88.2 kHz, 96 kHz, 176.4 kHz and 192 kHz
Microphone Inputs	
Dynamic Range	111 dB (A-weighted)
Frequency Response	20 Hz to 20 kHz \pm 0.1 dB
THD+N	< 0.0012% (minimum gain, -1 dBFS input with 22 Hz/22 kHz bandpass filter)
Noise EIN	-128 dB (A-weighted)
Maximum input level	+9 dBu (no PAD); +16 dBu (PAD selected); measured at minimum gain
Gain Range	56 dB
Input Impedance	3 k ohms
Line Inputs 1 & 2	
Dynamic Range	110.5 dB (A-weighted)
Frequency Response	20 Hz to 20 kHz \pm 0.1 dB
THD+N	< 0.002% (minimum gain, -1 dBFS input with 22 Hz/22 kHz bandpass filter)
Maximum input level	+22 dBu (no PAD); +29.5 dBu (PAD selected); measured at minimum gain
Gain Range	56 dB
Input Impedance	60 k ohms

Instrument Inputs 1 & 2	
Dynamic Range	110.5 dB (A-weighted)
Frequency Response	20 Hz to 20 kHz \pm 0.1 dB
THD+N	< 0.03% (minimum gain, -1 dBFS input with 22 Hz/22 kHz bandpass filter)
Maximum input level	+12.5 dBu (no PAD); +14 dBu (PAD selected); measured at minimum gain
Gain Range	56 dB
Input Impedance	1.5 M ohms
Line Inputs 3 to 6	
Dynamic Range	110.5 dB (A-weighted)
Frequency Response	20 Hz to 20 kHz \pm 0.1 dB
THD+N	< 0.002% (minimum gain, -1 dBFS input with 22 Hz/22 kHz bandpass filter)
Input Impedance	44 k ohms
Maximum input level	+18 dBu ; measured at minimum gain
Line Outputs 1 to 4	
Dynamic Range	108.5 dB (A-weighted)
Maximum Output Level (0 dBFS)	15.5 dBu (balanced)
THD+N	< 0.002% (minimum gain, -1 dBFS input with 22 Hz/22 kHz bandpass filter)
Output Impedance	430 ohms
Headphone Outputs	
Dynamic Range	104 dB (A-weighted)
Maximum Output Level	+7 dBu
THD+N	< 0.002% (measured at +6 dBu with 22 Hz/22 kHz bandpass filter)
Output Impedance	< 1 ohm

Physical and Electrical Characteristics

Analogue Inputs 1 & 2	
Connectors	XLR Combo type: Mic/Line/Inst, on front panel
Mic/Line switching	Automatic
Line/Instrument switching	Selected per channel from Focusrite Control
Pad	10 dB attenuation, selected per channel via Focusrite Control
Phantom power	Shared +48 V phantom power switch for inputs 1 & 2 (XLR connections only)
AIR function	Selected per channel via Focusrite Control
Analogue Inputs 3 to 6	
Connectors	4 x balanced ¼" TRS jacks on rear panel
Analogue Outputs 1 to 4	
Connectors	4 x balanced ¼" TRS jacks on rear panel
Stereo headphone outputs	2 x ¼" TRS jacks on front panel
Main monitor output level control	On front panel
Headphones level controls	
Other I/O	
S/PDIF I/O	2 x phono (RCA)
USB	1 x USB 2.0 Type C connector
MIDI I/O	2 x 5-pin DIN sockets
Front Panel indicators	
USB power	Green LED
Gain Halos	Tri-colour LED rings (concentric with GAIN controls)
Phantom power	Red LED
Instrument mode	2 x red LEDs
AIR mode	2 x amber LEDs
Pad active	2 x green LEDs
MIDI data received	Green LED
Power	Green LED

Weight and Dimensions	
W x D x H	210 mm x 149.5 mm x 47.5 mm 8.27" x 5.89" x 1.87"
Weight	0.84 kg 1.85 lbs

TROUBLESHOOTING

For all troubleshooting queries, please visit the Focusrite Help Centre at <https://support.focusrite.com/hc/en-gb> where you will find articles covering numerous troubleshooting examples.

COPYRIGHT AND LEGAL NOTICES

Your Scarlett 8i6 has a two-year warranty, valid anywhere in the world, against manufacturing defects. Full Terms and Conditions can be found at <https://focusrite.com/warranty>. Focusrite is a registered trade mark and Scarlett 8i6 is a trade mark of Focusrite Audio Engineering Limited.

All other trade marks and trade names are the property of their respective owners.
2019 © Focusrite Audio Engineering Limited. All rights reserved.